

06

# VASO PISCINA

## ÍNDICE

### PISCINAS DE HORMIGÓN

▶ Skimmers.....	184
▶ Regulador de nivel.....	185
▶ Sumideros .....	185
▶ Boquillas de impulsión.....	185
▶ Pasamuros hormigón.....	185
▶ Boquillas de aspiración .....	186
▶ Tapón de invierno.....	187
▶ Rejillas antitorbellino .....	187

### PISCINAS LINER Y POLIÉSTER

▶ Skimmers.....	188
▶ Sumidero.....	189
▶ Boquillas de impulsión .....	189
▶ Boquillas de aspiración .....	189

### HIDROTERAPIA

▶ Hidroterapia .....	190
----------------------	-----



## SKIMMER HORMIGÓN



500183

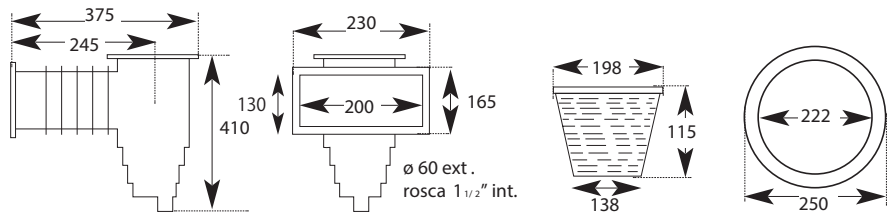

500185

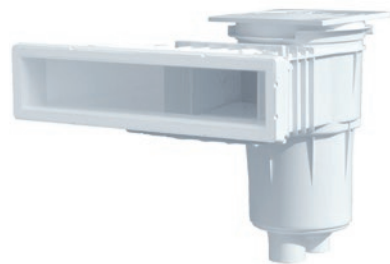
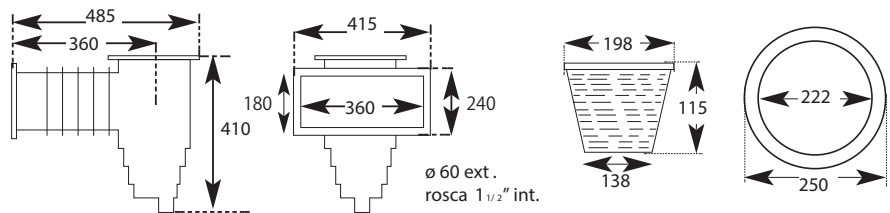

SKIMMER ESPEJO

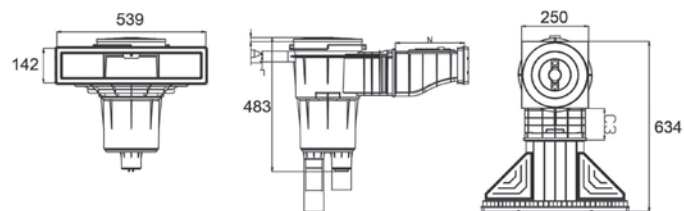

MODELO	BOCA		COD.	COD. EAN	PRECIO UD. €
TAPA REDONDA	200	1	500183	8410189011964	48,59
TAPA CUADRADA	200	1	500183C	8410189012824	49,69
TAPA REDONDA	360	1	500185	8410189015061	79,31
TAPA CUADRADA	360	1	500185C	8410189015078	80,34
SKIMMER ESPEJO	539	1	3139	-	289,00
SKIMMER ESPEJO GRAN BOCA GRIS	539	1	3139LG	-	316,46



## REGULADOR DE NIVEL

- ▶ Fabricado en ABS.
- ▶ Tapa cuadrada.
- ▶ Acometida ¾ macho.
- ▶ Registro 50 Ø H pegar.

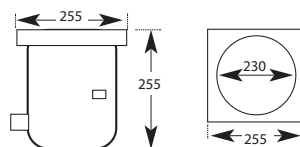

MODELO		COD.	COD. EAN	PRECIO UD. €
TAPA CUADRADA	1	500100	8410189004058	78,28

## SUMIDERO



- ▶ Fabricado en ABS con reja en ABS blanca o acero inox.
- ▶ 200 Ø.
- ▶ Salida roscada de 2" hembra.
- ▶ 11 m<sup>3</sup>/h aspiración.

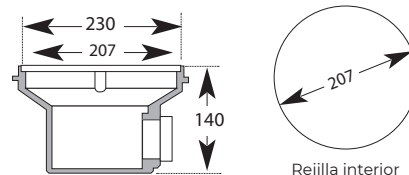

MODELO		COD.	COD. EAN	PRECIO UD. €
REJA ABS	1	500170	8410189004065	15,33
REJA ACERO	1	500174	8410189004072	50,21

## SUMIDERO CUADRADO



- ▶ Fabricado en ABS con reja en ABS blanca o acero inox.
- ▶ 200 Ø.
- ▶ Salida roscada de 2" hembra.
- ▶ 11 m<sup>3</sup>/h aspiración.

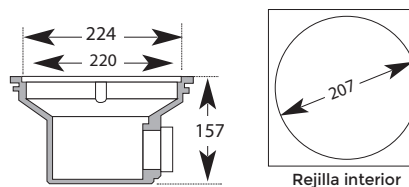

MODELO		COD.	COD. EAN	PRECIO UD. €
SUMIDERO CUADRADO	1	500172	-	19,36

## PASAMUROS HORMIGÓN



- ▶ Rosca interior 1.5" para focos planos y miniproyectores
- ▶ Fabricado en ABS.
- ▶ Longitud 260 mm.
- ▶ Conexión Ø 50 mm.
- ▶ Medidas: Int: 50 Ø - Ext: 63 Ø (mm)

MODELO		COD.	COD. EAN	UD. €	CAJA €
PASAMUROS	6	500231	8410189040872	6,85	41,10

## BOQUILLAS



BOQUILLA IMPULSIÓN

500199 / 500206 / 500207 / 500209 / 500211 / 500214



BOQUILLA IMPULSIÓN

500201 / 500212



BOQUILLA IMPULSIÓN

500215 / 500222



BOQUILLA IMPULSIÓN

500208 / 500213 / 500219 / 500217



BOQUILLA ASPIRACIÓN

500256 \* / 500269 \* / 500274 \*



BOQUILLA ASPIRACIÓN

500269R \* / 500274R \*

COD	TIPO PISCINA	CAUDAL (L/h)	TUBERIA PVC	CONEXIÓN ROSCA   ENCOLAR	COD EAN	UD CAJA	PRECIO UD €	PRECIO CAJA €
<b>BOQUILLAS IMPULSIÓN</b>								
500199	Hormigón	3000	50/06	2"/50	8410189004270	6	3,81	22,88
500206	Hormigón	5000	50/06	2"/50	8410189004287	6	3,80	22,82
500207	Hormigón	7000	50/06	2"/50	8410189004294	6	3,72	22,35
500209	Hormigón	3000	50/10	2"/50	8410189004300	6	3,75	22,47
500211	Hormigón	5000	50/10	2"/50	8410189004317	6	3,73	22,41
500214	Hormigón	7000	50/10	2"/50	8410189004324	6	3,75	22,47
500201	Hormigón	5000	50/10	2"/50	8410189034826	6	3,88	23,28
500212	Hormigón	5000	50/10	2"/50	8410189034833	6	3,55	21,31
500215	Hormigón	6000	50/10	2"/50	8410189004331	6	11,95	71,69
500222	Hormigón	6000	63/10	1 1/2"/63	8410189004348	6	12,28	73,69
500208	Hormigón	-	50/06	2"/50	8410189034840	6	5,30	31,78
500213	Hormigón	-	50/10	2"/50	8410189034857	6	4,19	25,15
500219	Hormigón	-	63/10	2"/63	8410189034860	6	12,15	72,88
500217	Hormigón	-	63/10	2"/63	8410189034871	6	11,36	68,16
<b>BOQUILLAS ASPIRACIÓN</b>								
500256	Hormigón	-	63/10	2"/50	8410189004409	6	6,82	40,89
500269	Hormigón	-	50/06	2"/50	8410189004416	6	4,77	28,59
500274	Hormigón	-	50/10	2"/50	8410189004423	6	4,76	28,54
500269R	Hormigón	-	50/06	2"/50	8410189034796	6	4,23	25,38
500274R	Hormigón	-	50/10	2"/50	8410189034802	6	4,08	24,47

Incluyen juntas y tornillos en acero inoxidable

\* Boquilla de aspiración, diseñada para facilitar la conexión de mangueras de limpiafondos de aspiración (manuales o automáticos).



## PASAMUROS

- ▶ Fabricado en ABS.
- ▶ Rosca exterior 2" con tuerca y junta.
- ▶ Interior encolar a tubo 50 por ambas bocas.

MODELO		COD.	COD. EAN	UD. €	CAJA €
PEGAR TUBO 50	6	500232	8410189004478	6,37	38,24

## TAPONES PARA EL INVIERNO



- ▶ Protegen el sistema de filtración.

MODELO		COD.	COD. EAN	UD. €	CAJA €
BOQUILLA 1 ½"	1	522260	8410189032440	1,63	1,63
BOQUILLA 2"	1	522261	8410189032457	2,08	2,08

06



## REJILLA ANTITORBELLINO

- ▶ Fabricada en ABS blanco.
- ▶ Evita torbellinos producidos por aspiración bomba.
- ▶ Para piscinas hormigón, liner y poliéster.
- ▶ Diámetro 316 mm.

MODELO		COD.	COD. EAN	UD. €	CAJA €
REJ. ANTITORBELLINO	6	500110	8410189025503	13,69	82,12

# SKIMMER LINER Y POLIÉSTER



500181

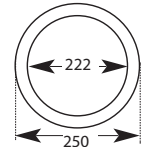
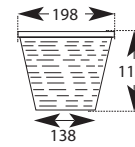
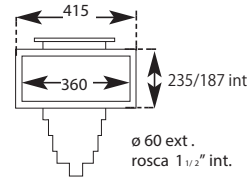
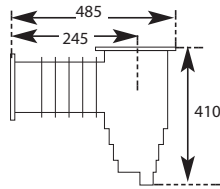

500186

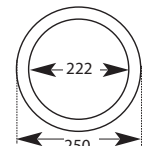
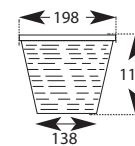
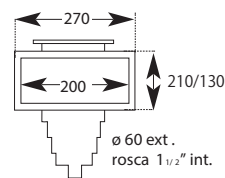
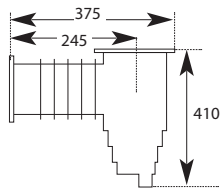

MODELO	BOCA		COD.	COD. EAN	PRECIO UD. €
TAPA REDONDA	360	1	500181	8410189015856	113,61
TAPA CUADRADA	360	1	500181C	8410189015092	114,55
TAPA REDONDA	200	1	500186	8410189025480	78,21
TAPA CUADRADA	200	1	500186C	8410189025497	79,22

# SKIMMER PISCINAS ELEVADAS

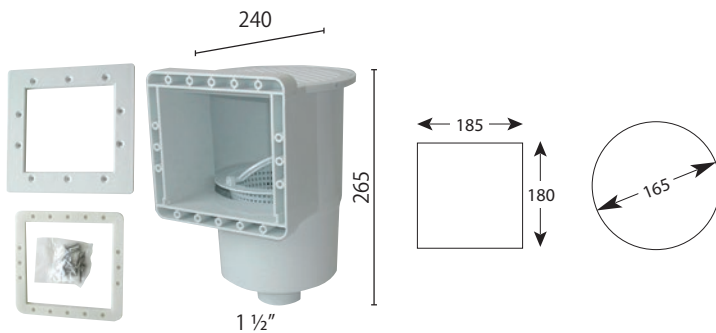

SKIMMER



SKIMMER FILTRANTE

MODELO	BOCA		COD.	COD. EAN	UD. €	CAJA €
SKIMMER	185	1	540200L	8410189035243	36,24	36,24
SKIMMER FILTRANTE	-	1	507402	8410189040377	145,08	145,08
Recambio filtro skimmer filtrante	-	6	540213G	8410189025619	11,05	66,32

RECAMBIO

## SKIMMER ESPEJO LINER

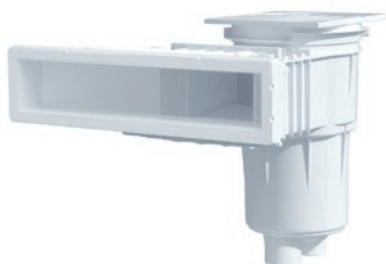

SKIMMER ESPEJO

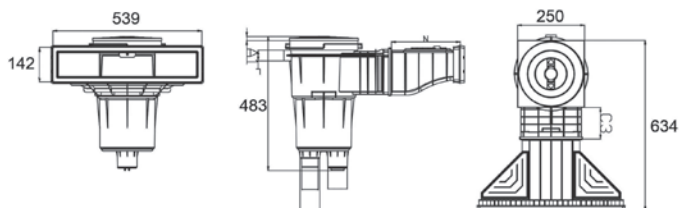

MODELO	BOCA		COD.	COD. EAN	PRECIO UD. €
SKIMMER ESPEJO	539	1	3139	-	289,00
SKIMMER ESPEJO GRAN BOCA GRIS	539	1	3139LG	-	316,46



## SUMIDERO PISCINAS PREFABRICADAS

- ▶ Con juntas de goma.
- ▶ Tornillos en acero inox.
- ▶ Reja ABS de 200 Ø.

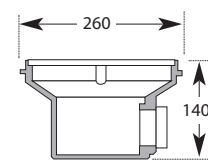

MODELO		COD.	COD. EAN	PRECIO UD. €
SUMIDERO	1	500178	8410189004089	38,37

## BOQUILLAS



BOQUILLA DE IMPULSIÓN PARA LINER

500223



BOQUILLA DE ASPIRACIÓN PARA LINER

500193



BOQUILLA DE IMPULSIÓN PISCINAS PREFABRICADAS

500224



BOQUILLA ASPIRACIÓN/IMPULSIÓN

522243

COD	TIPO PISCINA	CAUDAL (L/h)	TUBERÍA PVC	CONEXIÓN ROSCA   ENCOLAR	COD EAN	UD CAJA	PRECIO UD €	PRECIO CAJA €
<b>BOQUILLAS IMPULSIÓN</b>								
500223	-	6.000	-	-	8410189004355	6	14,94	89,62
500224	-	-	-	-	8410189034819	6	7,90	47,42
<b>BOQUILLAS ASPIRACIÓN</b>								
500193	-	-	-	-	8410189004430	6	15,07	90,45
522243	-	-	-	-	8410189035250	1	4,70	4,70

Incluyen juntas y tornillos en acero inoxidable





## TURBO JET

- ▶ Fácil instalación en obra.
- ▶ Adaptable a cualquier tipo de piscina.
- ▶ Sistema doble Venturi (mezcla aire-agua).
- ▶ Efecto hidromasaje.



SP1450WP



SP1450WP2



SP1450AC



### \*NOTA

El caudal de la bomba no debe ser inferior a 6 m<sup>3</sup>/h, ni superior a 15 m<sup>3</sup>/h.

	MODELO		COD.	COD. EAN	PRECIO UD. €
	<b>50 MM SLIP HORMIGÓN</b>	1	SP1450TE	0610377049887	<b>62,25</b>
	<b>1.5' MIP LINER</b>	1	SP1450TVE	3660149605015	<b>91,49</b>
OPCIÓN	Tapón de invernada con junta	1	SP1450WP2	0610377049986	<b>25,21</b>
	Tapón de invernada/Test con junta	1	SP1450WP	0610377049979	<b>48,04</b>
	Air Control para Turbo-Jet Liner	1	SP1450AC	3660149606050	<b>36,91</b>



SP1430



SP1430T

## JET AIR ACCESORIOS

- ▶ Se instala en obra tras la boquilla de impulsión, con toma de aire.
- ▶ Sistema doble Venturi (mezcla aire-agua).
- ▶ Efecto hidromasaje.

	MODELO		COD.	COD. EAN	PRECIO UD. €
	<b>BOQUILLA JET-AIR DELUXE INSTALACIÓN</b>	1	SP1430	0610377047890	<b>30,56</b>



SP1434EURO



SP14311

## JET AIR III

- ▶ Se instala con bomba para agua y aspiración de aire del exterior.
- ▶ Se unen varias unidades por medio de tubería flexible.
- ▶ Sistema doble Venturi (mezcla aire-agua).
- ▶ Efecto hidromasaje.

OPCIÓN

MODELO		COD.	COD. EAN	PRECIO UD. €
CUERPO JET-AIR III 32 MM SF	1	SP14341EPAK	0610377048255	49,70
CUERPO JET-AIR III 50 MM SF	1	SP1434EURO	0610377485265	59,45
CUERPO JET-AIR III 1.5' SKT	1	SP1434PAKA	0610377048095	37,92
JET-AIR DELUXE (EN PISC.) TUBO 45CM	1	SP14311	0610377047968	57,73
Llave Jet-Air III	1	SP1434T	0610377048187	32,33



SP1434PAKB



SP1436PAKB

## JET ORIENTABLE PAK B

- ▶ Cabezal mezclador que se rosca en el interior del Jet SP1434.
- ▶ Se puede orientar (SP1434PAKB).
- ▶ Dos salidas que se mezclan al girar (SP1436PAKB).
- ▶ Efecto hidromasaje.

OPCIÓN

MODELO		COD.	COD. EAN	PRECIO UD. €
JET-AIR III VARI-FLO NOZZLE	1	SP1434PAKB	0610377048118	22,38
JET-AIR III PULSE FLO NOZZLE	1	SP1436PAKB	0610377048545	36,79
Boquilla tobera flexible	1	SP1420	0610377047722	10,09



IE3 ✓

## CONTRACORRIENTE CALIPSO

- ▶ Boquilla oscilante y ajustable 40 mm.
- ▶ Parte delantera del diseño atractivo con botón pulsador incorporado.
- ▶ Carcasa para preinstalación con válvula de retención y tubos de aire.
- ▶ Electrobomba HCP 1000 Serie, potencia según modelo.
- ▶ Panel electroneumático para el control y la protección de la bomba.
- ▶ Kit completo PVC (tubo no incluido).

MODELO		COD.	COD. EAN	PRECIO UD. €
JC 40 CALIPSO HIDROJET 2,5 MONO	1	JC40	-	2.721,00
JC 45 CALIPSO HIDROJET 3 MONO	1	JC45	-	2.793,37
JC 46 CALIPSO HIDROJET 3 TRI	1	JC46	-	2.670,17
JC 70 CALIPSO HIDROJET 3,5 TRI	1	JC70	-	2.794,94
JC 78 CALIPSO HIDROJET 4,5 TRI	1	JC78	-	2.885,69
JC 88 CALIPSO HIDROJET 5,5 TRI	1	JC88	-	2.676,11